

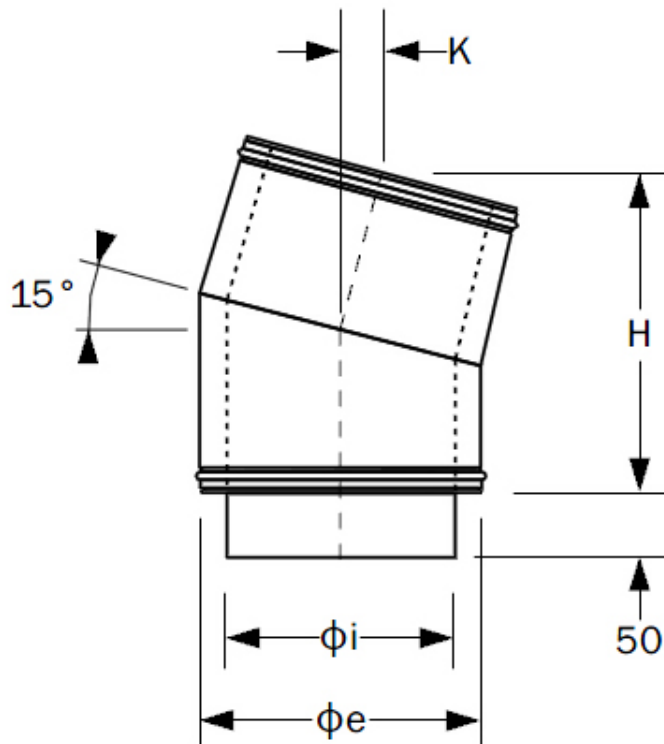

www.chimneychoice.ie

15° Bend TWR

Inner Diameter ϕ_i (mm)	Outer Diameter ϕ_e (mm)	H (mm)	K (mm)
130	180	220	29
150	200	222	29



All information and images are owned and copyrighted by SHL Distributors Ltd. This PDF is not to be reproduced in any format or stored on any device unless for personal use.



www.chimneychoice.ie

Offset Measurements for 15° Bend TWR

Inner Diameter ϕ_i (mm)	Outer Diameter ϕ_e (mm)	L (mm)	A (mm)	B (mm)
130	180	0	58	440
		100	90	560
		205	112	638
		450	175	874
		950	304	1356
150	200	0	58	444
		100	90	580
		205	112	643
		450	175	880
		950	304	1362

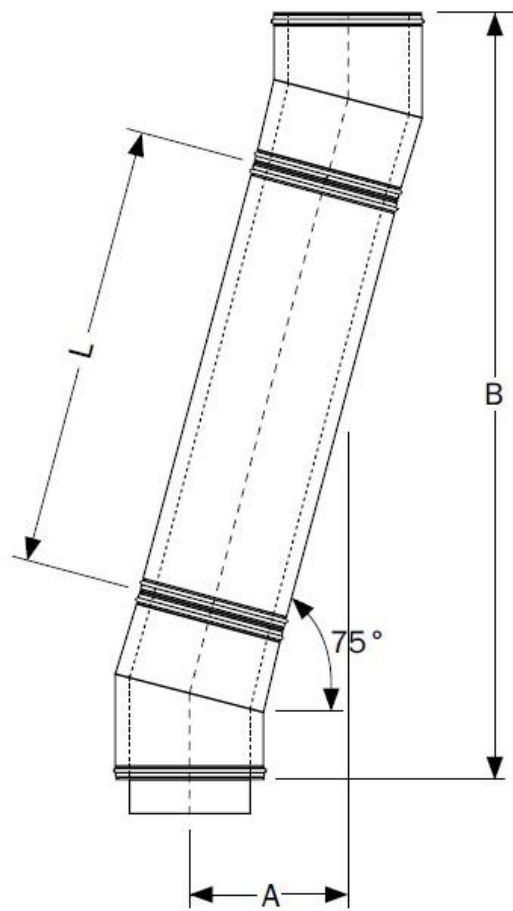

All information and images are owned and copyrighted by SHL Distributors Ltd. This PDF is not to be reproduced in any format or stored on any device unless for personal use.